

Model: **DI031-601H<sup>+</sup>**

**Roof Mount Centrifugal Fan**

**Horizontal Discharge**

*General Information:*

Common Applications:

General Ventilation

Suitable for roof installation up to 15° from horizontal

Galvanised steel base

UV stabilised fibreglass cowl  
- colour Colorbond "Dune"

High efficiency backward curved impeller directly driven by IP44 external rotor motor

Removable lifting lugs for ease of installation

*Model Specification:*

Power / Current	<b>0.07 kW / 0.34 A</b>
Speed	<b>920 rpm</b>
Power Supply	240V single phase 50 Hz
dBA@3m	<b>37</b>
Mass / Weight	20 kg

+ Refer to wiring diagram WD1-01 available on [www.aerovent.com.au/downloads](http://www.aerovent.com.au/downloads)

\* Performance standard ISO 5801

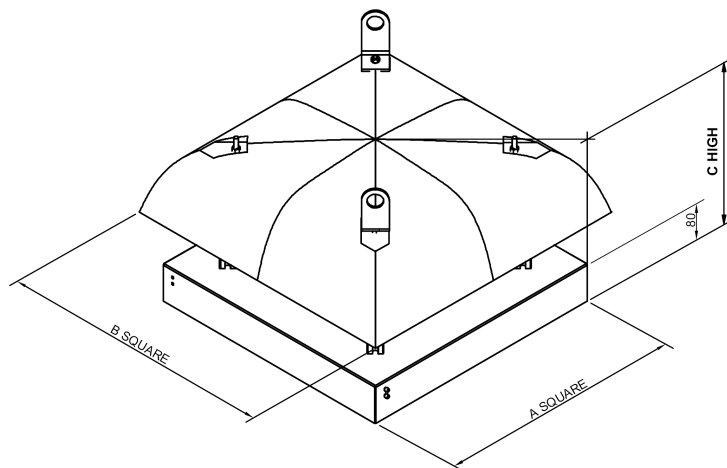
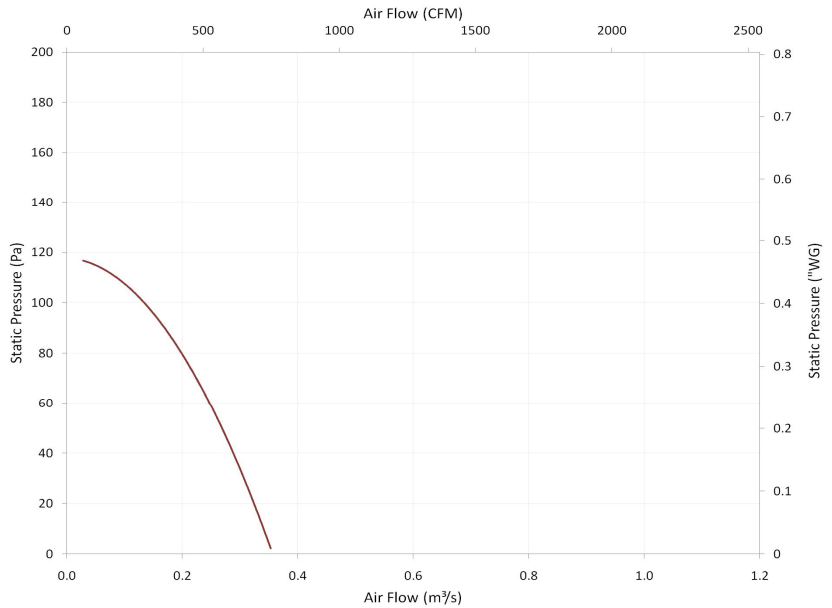

			Recommended upstand dimensions (supplied by others)		
A	B	C	Max. outside	Min. inside	Min. height
540	600	555	530	430	90

*Series* **DIAMOND**

[www.aerovent.com.au](http://www.aerovent.com.au)



Due to Aerovent Australia's constant product improvement and development program, product details may change without prior notice.