

Model: **DI045-401H⁺**

Roof Mount Centrifugal Fan

Horizontal Discharge

General Information:

Common Applications:

General Ventilation

Suitable for roof installation up to 15° from horizontal

Galvanised steel base

UV stabilised fibreglass cowl
- colour Colorbond "Dune"

High efficiency backward curved impeller directly driven by IP54 external rotor motor

Removable lifting lugs for ease of installation

Model Specification:

Power / Current	0.73 kW / 3.30 A
Speed	1230 rpm
Power Supply	240V single phase 50 Hz
dBA@3m	52
Mass / Weight	35 kg

+ Refer to wiring diagram WD1-01 available on www.aerovent.com.au/downloads

* Performance standard ISO 5801

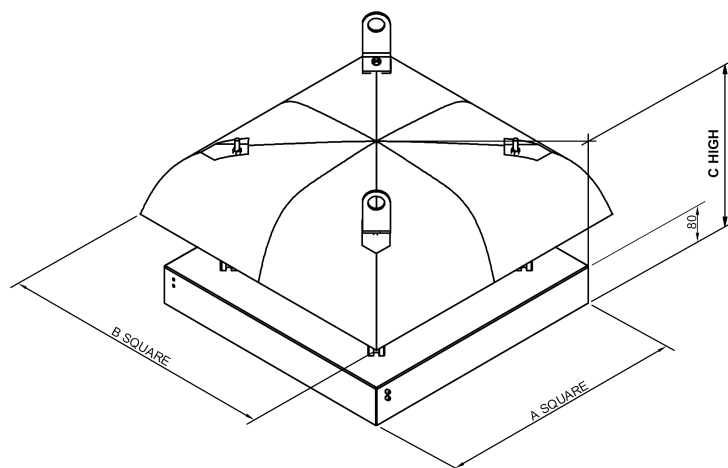
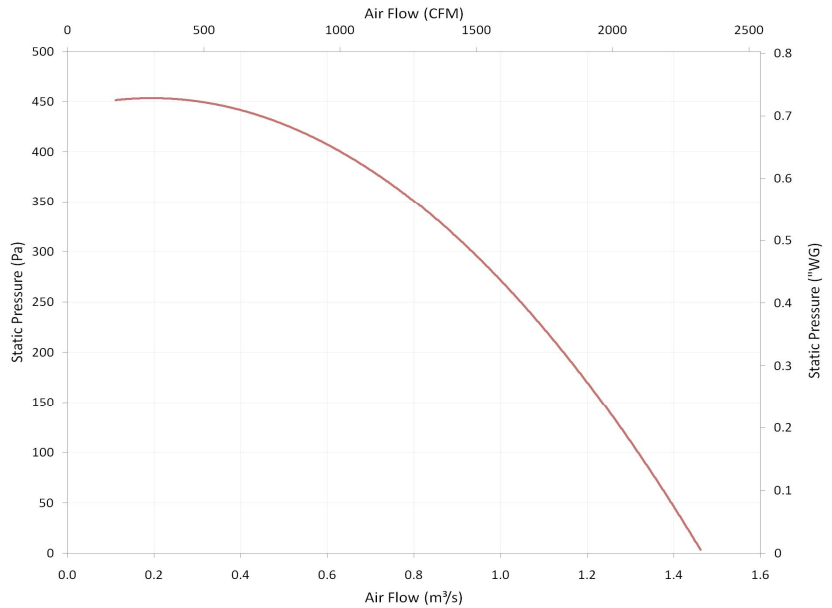

			Recommended upstand dimensions (supplied by others)		
A	B	C	Max. outside	Min. inside	Min. height
655	710	689	645	545	90

Series **DIAMOND**

www.aerovent.com.au



Due to Aerovent Australia's constant product improvement and development program, product details may change without prior notice.