

Model: **DI063-603H⁺**
DI063-083H⁺
DI063-683H⁺⁺

Roof Roof Mount Centrifugal Fan

Horizontal Discharge

General Information:

Applications: General Ventilation

Suitable for roof installation up to 15° from horizontal

Galvanised steel base

UV stabilised fibreglass cowl
- colour Colorbond "Dune"

High efficiency backward curved impeller directly driven by IP54 external rotor motor

Removable lifting lugs for ease of installation

Model Specification:

Model	603 / 083
Power / Current	1.0 / 0.62 kW 2.0 / 1.10 A
Speed	897 / 650 rpm
Power Supply	415V Three phase 50 Hz
dBA@3m	55 / 47
Mass / Weight	90 kg

+ Refer to wiring diagram WD3-01 for different speed settings, available on www.aerovent.com.au/downloads

++ dual-speed fan operates with a dual-speed switch (available as optional accessory)

* Performance standard ISO 5801

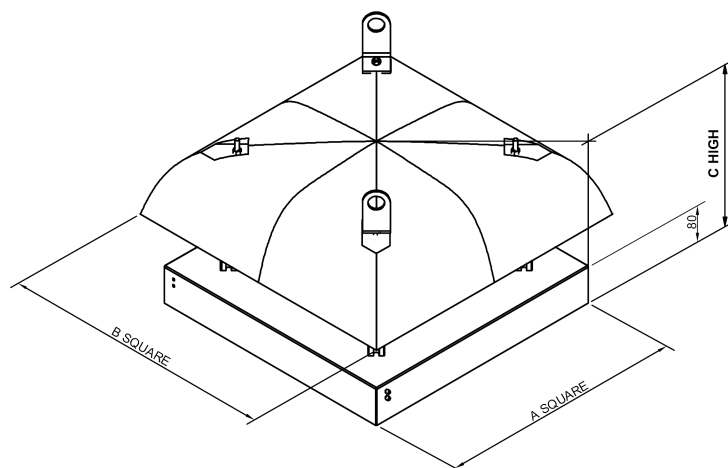
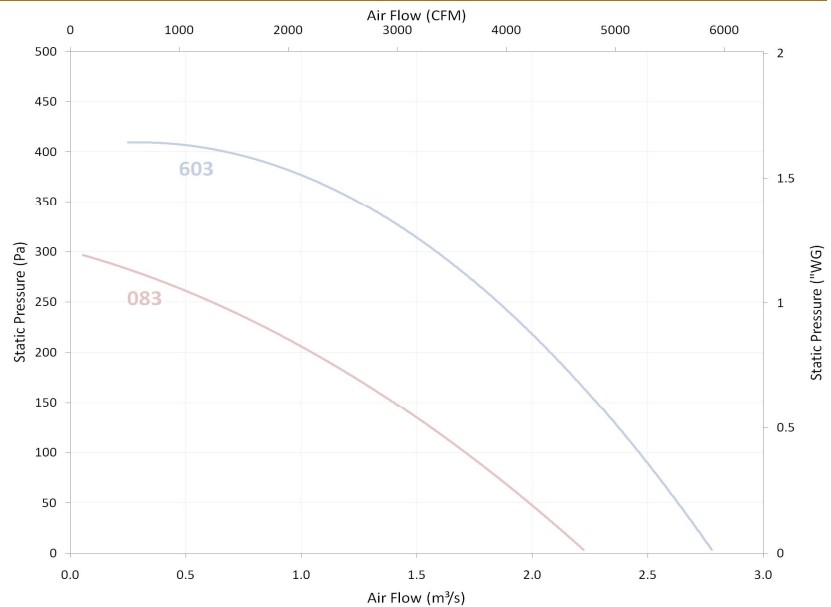

			Recommended upstand dimensions (supplied by others)		
A	B	C	Max. outside	Min. inside	Min. height
950	1040	995	940	840	90

