

**Amethyst Series: Plate Mounted Axial  
Model: AM035-401**



**Common Applications**

Suitable for wall or panel mounted applications, the Amethyst Series incorporate a finger guard on the fan inlet standard.

**Electrical**

Available in 240V single-phase and 415V three-phase. Motors are speed controllable, three-phase motors are 2-speed star/delta type.

**Materials**

High efficiency fixed pitch axial impeller with external rotor motor.  
Galvanised steel fan casing with powder coat finish on some sizes as standard.

**Protection**

IP44 external rotor motor with integral thermal protection.

**Warning**

Warranty may be void if wiring and installation guidelines are not followed.

Refer to wiring diagram WD1-02 available at [www.aerovent.com.au/downloads](http://www.aerovent.com.au/downloads)  
Performance Standard ISO 5801

**Aerovent Australia Pty. Ltd.**

**Head Office - Victoria**

31 Hosie Street

Bayswater, Victoria 3153

Phone: +61 (0)3 9720 8088

Fax: +61 (0)3 9720 7133

Email: [sales@aerovent.com.au](mailto:sales@aerovent.com.au)

Project:

Fan Ref:

**Performance Data**

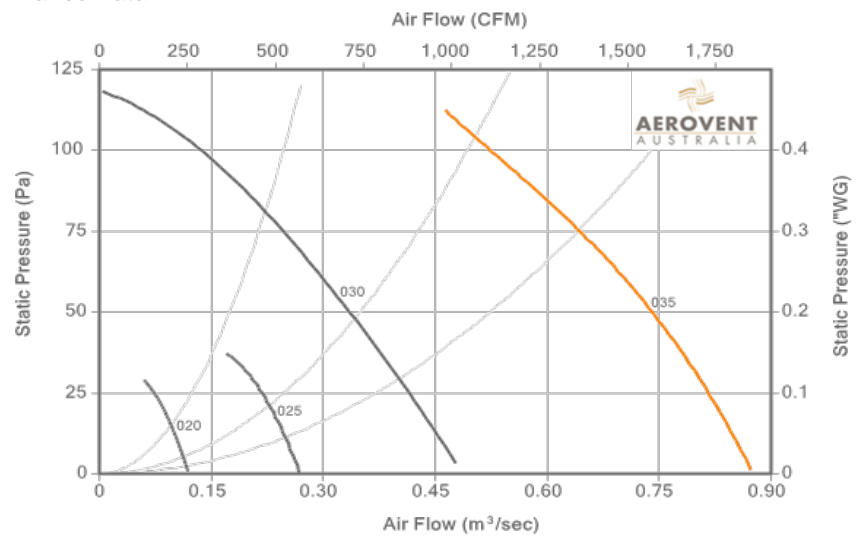

**Model Specifications**

Power, kW	Current, Amps	Speed, RPM	Power Supply	dB(A) @ 3m	Mass, kg
0.2	0.99	1400	240V / 1Ph / 50Hz	49	16

**Sound Power Level (dB re10-12 W) at Octave Band Mid-Frequency (Hz)**

63	125	250	500	1k	2k	4k	8k
61	70	65	64	65	65	61	54

**Dimensions, mm**

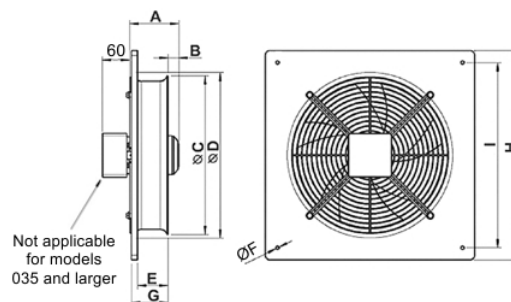

A	B	C
107	33	358
D	E	F
435	74	9
G	H	I
86	485	435

Due to Aerovent Australia's constant product improvement and development program, product details may change without prior notice. Copyright © 2019 Aerovent Australia. All rights reserved.