

**Amethyst Series: Plate Mounted Axial
Model: AM040-401**



Common Applications

Suitable for wall or panel mounted applications, the Amethyst Series incorporate a finger guard on the fan inlet standard.

Electrical

Available in 240V single-phase and 415V three-phase. Motors are speed controllable, three-phase motors are 2-speed star/delta type.

Materials

High efficiency fixed pitch axial impeller with external rotor motor.
Galvanised steel fan casing with powder coat finish on some sizes as standard.

Protection

IP44 external rotor motor with integral thermal protection.

Warning

Warranty may be void if wiring and installation guidelines are not followed.

Refer to wiring diagram WD1-02 available at www.aerovent.com.au/downloads
Performance Standard ISO 5801

Aerovent Australia Pty. Ltd.

Head Office - Victoria

31 Hosie Street
Bayswater, Victoria 3153
Phone: +61 (0)3 9720 8088
Fax: +61 (0)3 9720 7133
Email: sales@aerovent.com.au

Project:

Fan Ref:

Performance Data

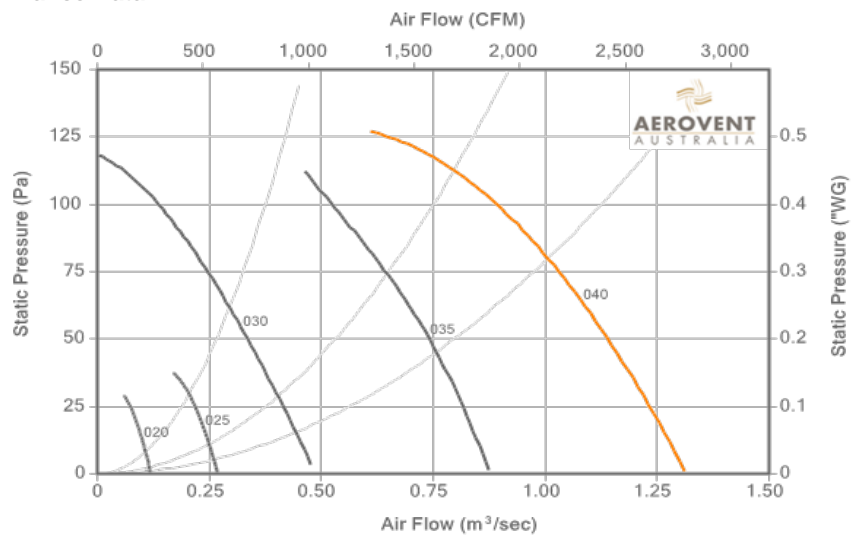

Model Specifications

Power, kW	Current, Amps	Speed, RPM	Power Supply	dB(A) @ 3m	Mass, kg
0.13	1.35	1320	240V / 1Ph / 50Hz	49	20

Sound Power Level (dB re10-12 W) at Octave Band Mid-Frequency (Hz)

63	125	250	500	1k	2k	4k	8k
73	73	64	64	65	64	63	55

Dimensions, mm

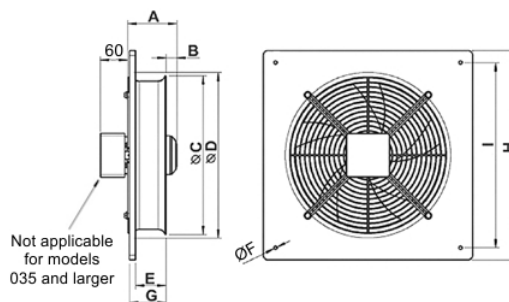

A	B	C
117	29	403
D	E	F
490	88	9
G	H	I
100	540	490

Due to Aerovent Australia's constant product improvement and development program, product details may change without prior notice. Copyright © 2019 Aerovent Australia. All rights reserved.