

**Amethyst Series: Plate Mounted Axial
Model: AM045-063**



Common Applications
Suitable for wall or panel mounted applications, the Amethyst Series incorporate a finger guard on the fan inlet standard.

Electrical
Available in 240V single-phase and 415V three-phase. Motors are speed controllable, three-phase motors are 2-speed star/delta type.

Materials
High efficiency fixed pitch axial impeller with external rotor motor.
Galvanised steel fan casing with powder coat finish on some sizes as standard.

Protection
IP44 external rotor motor with integral thermal protection.

Warning
Warranty may be void if wiring and installation guidelines are not followed.

Refer to wiring diagram WD3-01 available at www.aerovent.com.au/downloads
Performance Standard ISO 5801

Aerovent Australia Pty. Ltd.

Head Office - Victoria
31 Hosie Street
Bayswater, Victoria 3153
Phone: +61 (0)3 9720 8088
Fax: +61 (0)3 9720 7133
Email: sales@aerovent.com.au

Project:

Fan Ref:

Performance Data

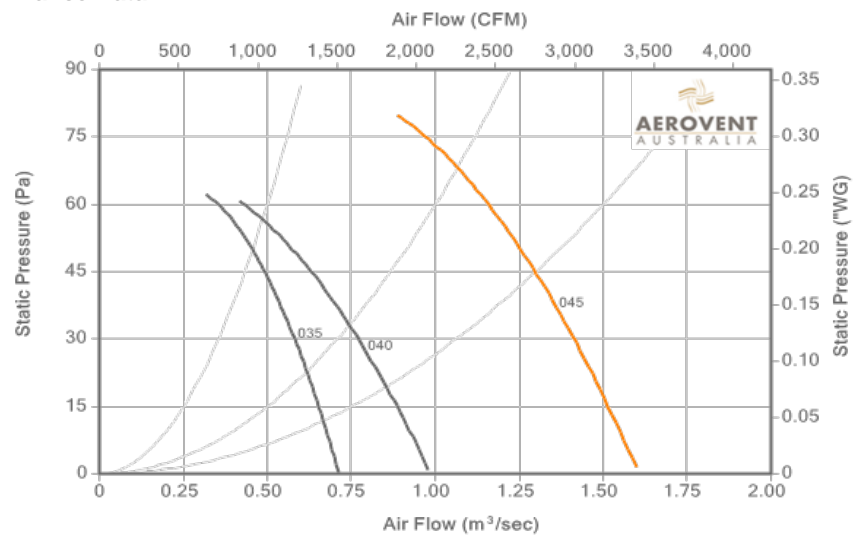

Model Specifications

Power, kW	Current, Amps	Speed, RPM	Power Supply	dB(A) @ 3m	Mass, kg
0.38	0.68	1030	415V / 3Ph / 50Hz	48	22

Sound Power Level (dB re10-12 W) at Octave Band Mid-Frequency (Hz)

63	125	250	500	1k	2k	4k	8k
71	69	63	63	64	63	57	50

Dimensions, mm

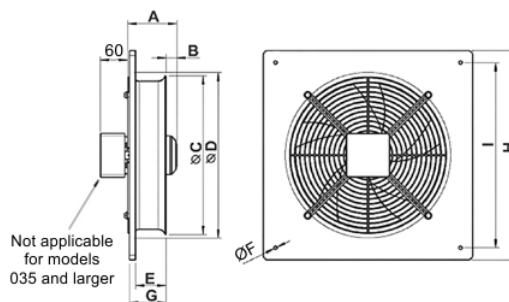

A	B	C
147	61	425
D	E	F
535	86	11
G	H	I
100	576	535