

Model: **AMP 056-1**

Pre-engineered, flame proof, direct drive axial flow fans

Performance:

Flow rate range - 0.3m³/s to 2.9 m³/s
 Static pressures up to 150 Pa
 Electric motors 0.55W 240V single phase Ex'd'
 Anti-static impeller blades

Common Applications:

Battery Room Exhaust
 Spray booth

The AMP Series is plate mount to suit wall installation.

Ancillary items such as weather cowl or wire guard can be fitted directly to tailor for a specific application.

Power / Current	0.55 kW / 3.7 A
Speed	1420 rpm
Power Supply	240V Single phase 50 Hz
dBA@3m	61

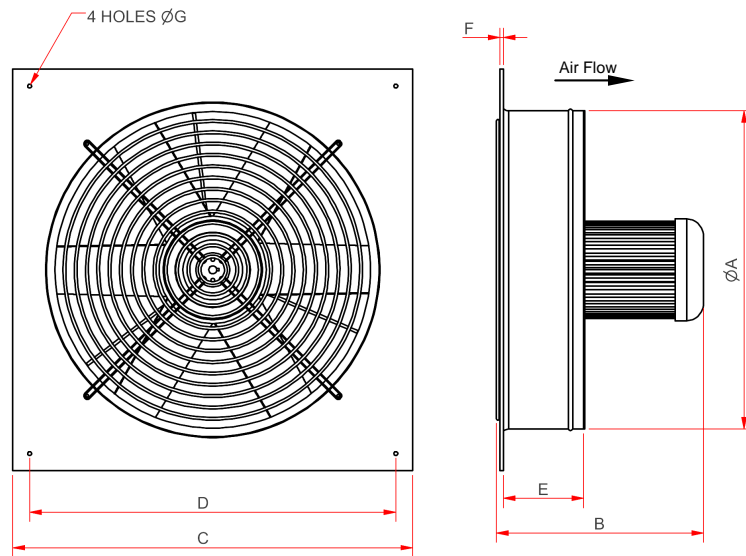
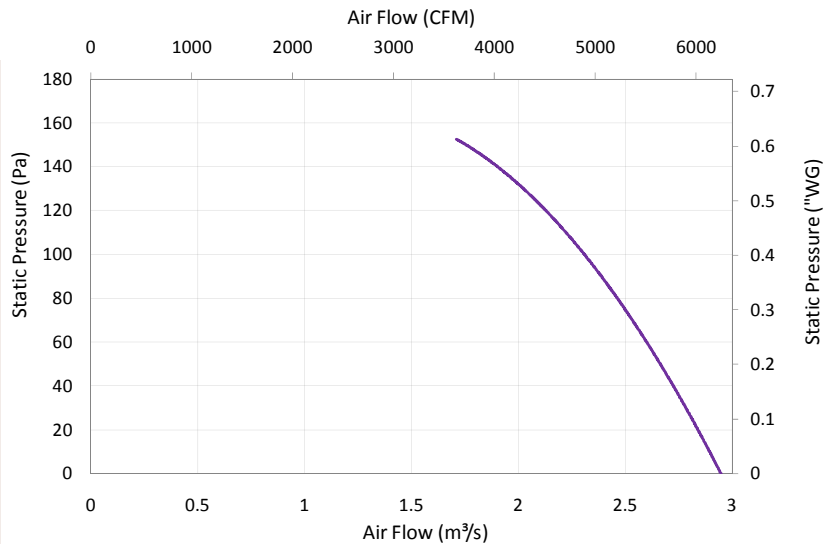

+ Refer to wiring diagram WD1-11 for different speed settings, available on www.aerovent.com.au/downloads

* Performance standard ANSI / AMCA 210-99

** Electric motor is certified for Group I & IIB, Hazardous Zone 1 Ex'd' area.

A	B	C	D	E	F	G
559	395	725	675	120	16	11

